



TAI-SAW TECHNOLOGY CO., LTD.

No. 3, Industrial 2nd Rd., Ping-Chen Industrial District,
Taoyuan, 324, Taiwan, R.O.C.

TEL: 886-3-4690038 FAX: 886-3-4697532

E-mail: tstsales@mail.taisaw.com Web: www.taisaw.com

Product Specifications Approval Sheet

Product Name: SAW Filter 725.5 MHz SMD 3.0X3.0 mm

TST Parts No.: TA2615A

Customer Parts No.: _____

Company: _____
Division: _____
Approved by : _____
Date: _____

Checked by: _____ Sam Lin *Sam Lin*

Approval by: _____ Andy Yu *Andy Yu*

Date: _____ 2019/12/24

1. Customer signed back is required before TST can proceed with sample build and receive orders.
2. Orders received without customer signed back will be regarded as agreement on the specifications.
3. Any specifications changes must be approved upon by both parties and a new revision of specifications shall be released to reflect the changes



TAI-SAW TECHNOLOGY CO., LTD.

No. 3, Industrial 2nd Rd., Ping-Chen Industrial District,
Taoyuan, 324, Taiwan, R.O.C.

TEL: 886-3-4690038 FAX: 886-3-4697532

E-mail: tstsales@mail.taisaw.com Web: www.taisaw.com

SAW Filter 725.5 MHz SMD 3.0X3.0 mm

MODEL NO.:TA2615A

REV. NO.:1.0

A. MAXIMUM RATING:

1. Input Power Level: 15 dBm
2. DC Voltage : 0 V
3. Operating Temperature: +0°C to +85°C
4. Storage Temperature: -40°C to +85°C

RoHS Compliant

Lead-free soldering

Electrostatic Sensitive Device (ESD)

B. ELECTRICAL CHARACTERISTICS:

Terminating source impedance (single) : $Z_s = 50 \Omega$

Terminating load impedance (single) : $Z_L = 50 \Omega$

Item	Unit	Min.	Type.	Max.
Center Frequency	MHz	-	725.5	-
Insertion Loss (703 ~ 748 MHz)	dB	-	2.5	3.5
Amplitude ripple (703 ~ 748 MHz)	dB	-	1.5	2.5
VSWR (703 ~ 748 MHz)	-	-	2.2	2.5
Attenuation				
10 ~ 670 MHz	dB	25	31	-
670 ~ 690 MHz	dB	15	37	-
758 ~ 803 MHz	dB	10	24	-
803 ~ 1000 MHz	dB	25	30	-
1000 ~ 3000 MHz	dB	25	30	-
Temperature Coefficient of Frequency	ppm/C°	-	-36	-

C. TEST CIRCUIT:

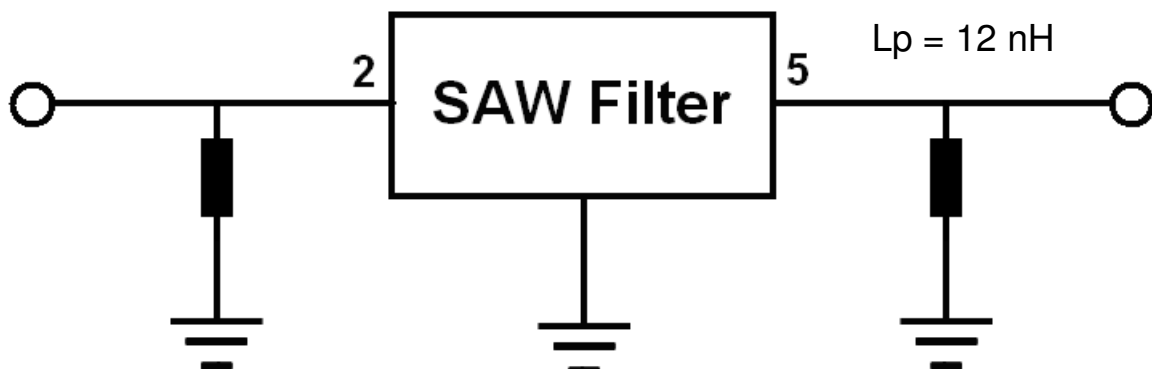

D. OUTLINE DRAWING:

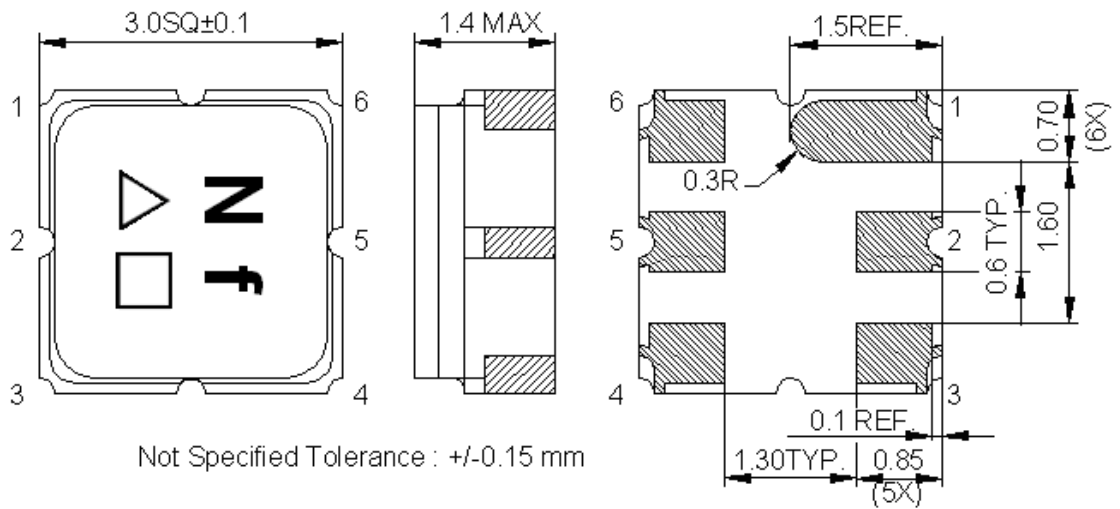

2: Input

5: Output

Other: Ground

Unit: mm

Δ : Year Code (2009->9, 2010->0, ..., 2018->8)

\square : Date Code (Follow the table from planner each year)

WK01	WK02	WK03	WK04	WK05	WK06	WK07	WK08	WK09	WK10	WK11	WK12	WK13
A	B	C	D	E	F	G	H	I	J	K	L	M
WK14	WK15	WK16	WK17	WK18	WK19	WK20	WK21	WK22	WK23	WK24	WK25	WK26
N	O	P	Q	R	S	T	U	V	W	X	Y	Z
WK27	WK28	WK29	WK30	WK31	WK32	WK33	WK34	WK35	WK36	WK37	WK38	WK39
a	b	c	d	e	f	g	h	i	j	k	l	m
WK40	WK41	WK42	WK43	WK44	WK45	WK46	WK47	WK48	WK49	WK50	WK51	WK52
n	o	p	q	r	s	t	u	v	w	x	y	z

E. Frequency Characteristics:

Span 400 MHz

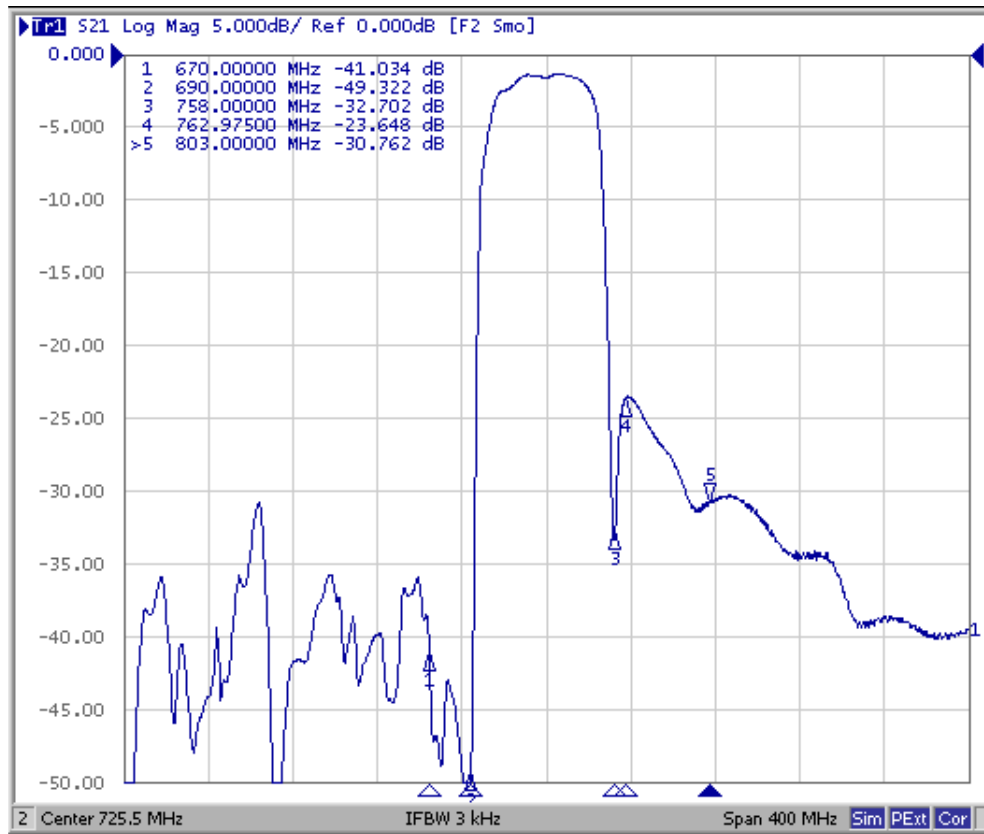

Span 3000 MHz

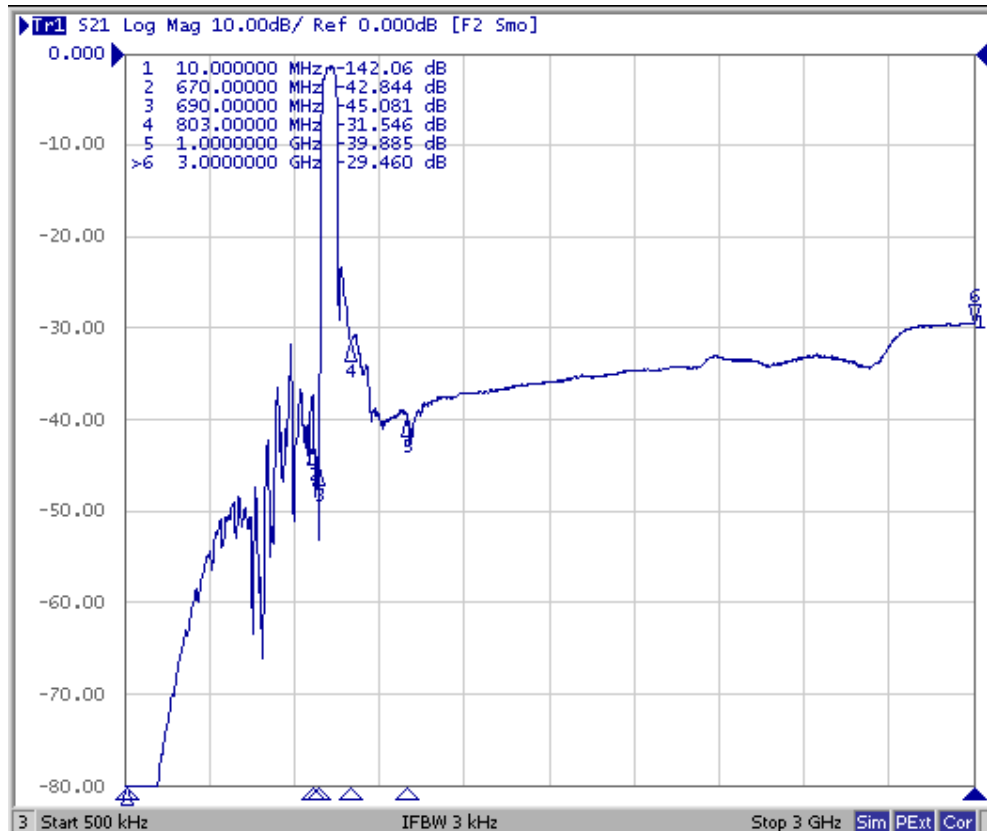

Span 100 MHz

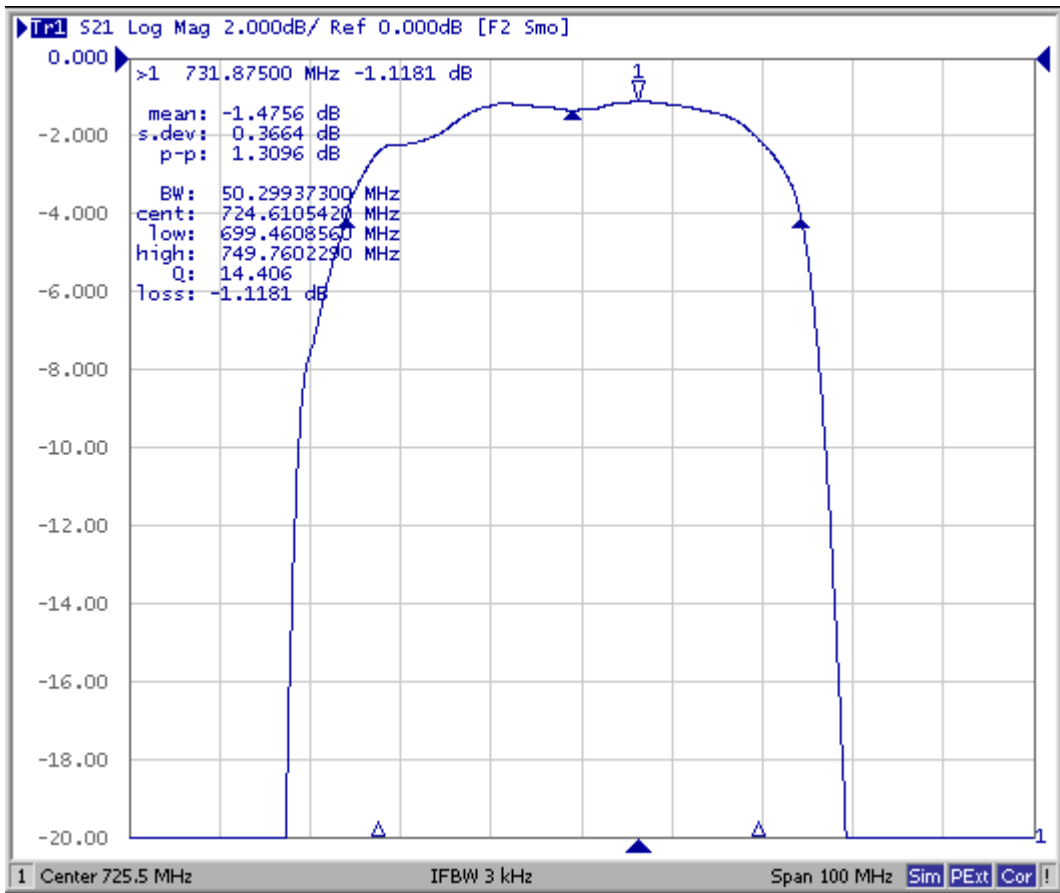

Reflection Characteristic

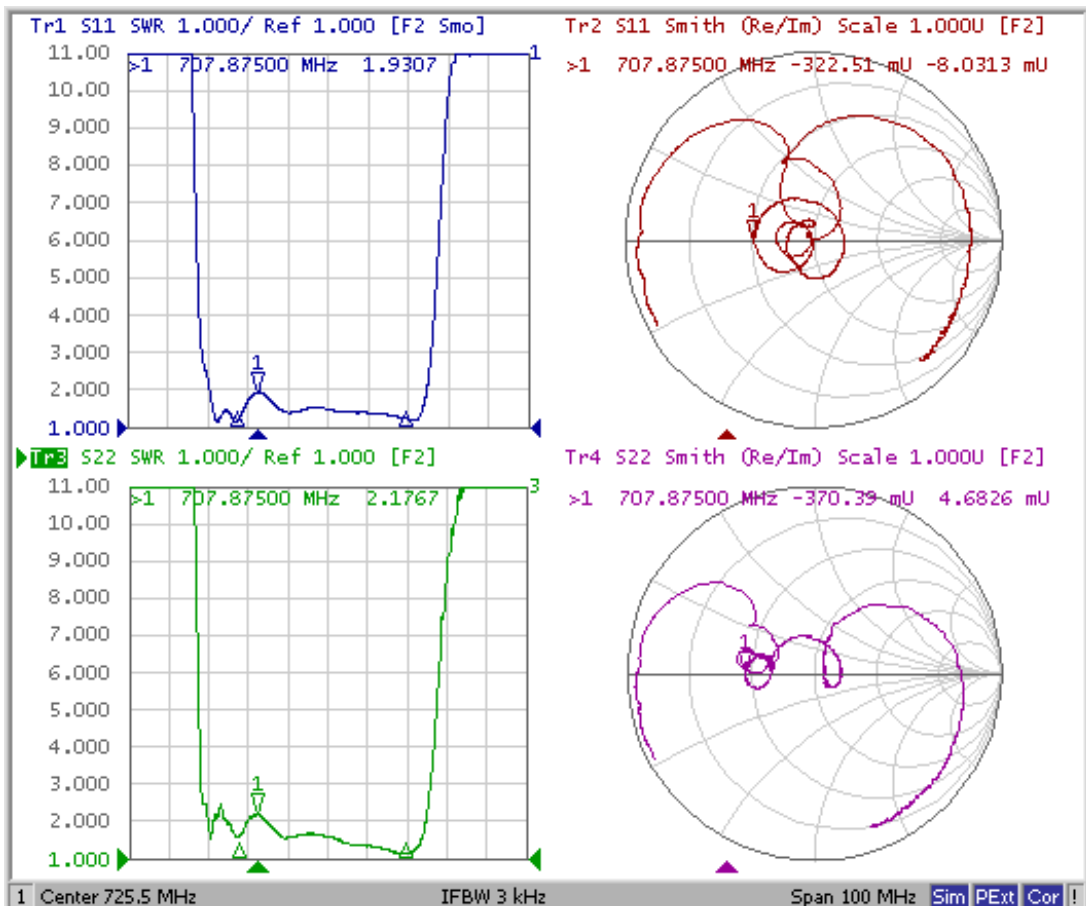

F. PCB FOOTPRINT:

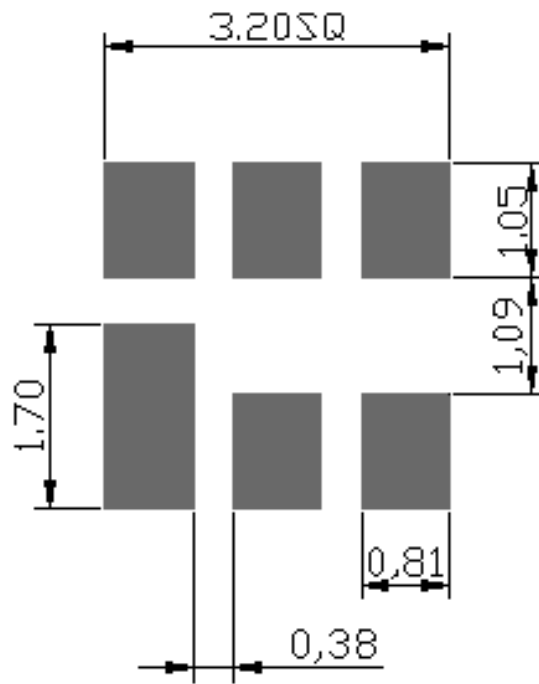

H. RECOMMENDED REFLOW PROFILE :

1. Preheating shall be fixed at 150~180°C for 60~90 seconds.
2. Ascending time to preheating temperature 150°C shall be 30 seconds min.
3. Heating shall be fixed at 220°C for 50~80 seconds and at 260°C +0/-5°C peak (20~40sec).
4. Time: 2 times.

